



ROCKER SWITCH

Part No.

KCD5-201

KCD5-201

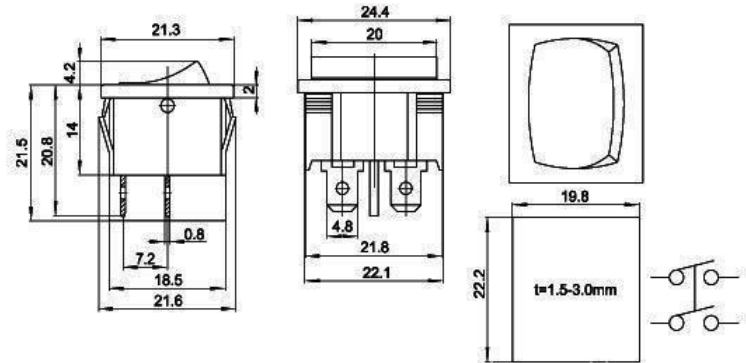

Parameter

Types:	ON-OFF;ON-ON;ON-OFF-ON
Actuator:	Polycarbonate
Base:	Nylon (PA) 66
Contacts:	Silver plated Copper/Silver Alloy
Life:	≥10000times
Terminals:	Tin-Plated Copper
Movable Arm:	Tin-Plated Copper
Dielectric Strength:	1500V for 1 Min
Insulation Resistance:	≥100MΩ

Characteristic

Rated Voltage:	6A 250VAC
Rated Current:	10A 125VAC
Insulated Resistance:	≥100MΩ
Contact Resistance:	≤50MΩ
Dielectric Strength:	1500VAC/5S
Endurance:	≥10000 Cyckes
Ambient Temp:	T85
Contact Resistance:	≤30mΩ
Temperature Range:	-30~85°C

Model Description

e.g
KCD 5 - 2 01 (E) (N) -2 C7- R / R
 ① ② ③ ④ ⑤ ⑥ ⑦ ⑧ ⑨ ⑩

- ① Rocker Switch
- ② Big Type
- ③ Poles
- ④ Circuit Function
- ⑤ Dot
- ⑥ Neon Lamp
- ⑦ Product Number
- ⑧ Cap Marking
- ⑨ Cap Color
- ⑩ Base Color

Circuitry Trait

- 01 ON - OFF
- 02 ON - OFF
- 11 <ON> OFF
- 12 ON - <ON>
- 03 ON OFF ON
- 13 ON OFF <ON>
- 23 <ON> OFF <ON>

< > : Indicates Momentary

Cap Color

- Black
- White <W>
- Red <R>
- Yellow <Y>
- Green <G>
- Orange <O>
- Gray <GR>

Base Color

- Black
- White <W>
- Gray <GR>

Ratings for different series:

- KCD1 10A 125VAC; 6A 250VAC
- KCD2 20A 125VAC; 15A 250VAC; 35A 12VDC
- KCD3 20A 125VAC; 15A 250VAC; 35A 13VDC
- KCD4 15A 250VAC; 30A 250VAC
- KCD5 6A 125VAC ; 3A 250VAC

Cap Marking

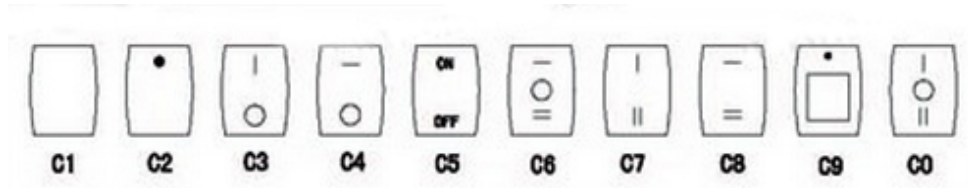

DIMENSIONS (Unit: mm)

