

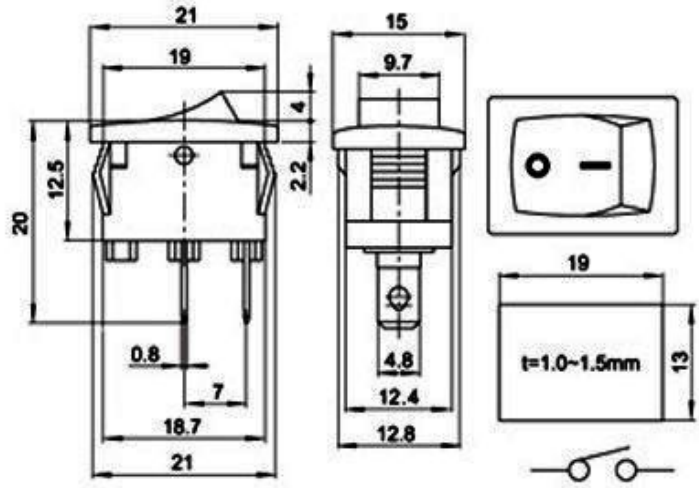

ROCKER SWITCH

Part No.
KCD1A-101

KCD1A-101



Parameter

Types:	ON-OFF;ON-ON;ON-OFF-ON
Actuator:	Polycarbonate
Base:	Nylon (PA) 66
Contacts:	Silver plated Copper/Silver Alloy
Life:	≥10000times
Terminals:	Tin-Plated Copper
Movable Arm:	Tin-Plated Copper
Dielectric Strength:	1500V for 1 Min
Insulation Resistance:	≥100MΩ

Characteristic

Rated Voltage:	10A 125VAC
Rated Current:	6A 250VAC
Insulated Resistance:	≥100MΩ
Contact Resistance:	≤50MΩ
Dielectric Strength:	1500VAC/5S
Endurance:	≥10000 Cyckes
Ambient Temp:	T85
Contact Resistance:	≤30mΩ
Temperature Range:	-30~85°C

Model Description

e.g

KCD 1 - 1 01 (E) (N) -2 C7- R / R

- ① ② ③ ④ ⑤ ⑥ ⑦ ⑧ ⑨ ⑩

- ① Rocker Switch
- ② Small Type
- ③ Poles
- ④ Circuit Function
- ⑤ Dot
- ⑥ Neon Lamp
- ⑦ Product Number
- ⑧ Cap Marking
- ⑨ Cap Color
- ⑩ Base Color

Circuitry Trait

- 01 ON - OFF
- 02 ON - OFF
- 11 <ON> OFF
- 12 ON - <ON>
- 03 ON OFF ON
- 13 ON OFF <ON>
- 23 <ON> OFF <ON>

Cap Color

- Black
- White <W>
- Red <R>
- Yellow <Y>
- Green <G>
- Orange <O>
- Gray <GR>

Base Color

- Black
- White <W>
- Gray <GR>

Ratings for different series:

- KCD1 10A 125VAC; 6A 250VAC
- KCD2 20A 125VAC; 15A 250VAC; 35A 12VDC
- KCD3 20A 125VAC; 15A 250VAC; 35A 13VDC
- KCD4 15A 250VAC; 30A 250VAC
- KCD5 6A 125VAC ; 3A 250VAC

< > : Indicates Momentary

Cap Marking

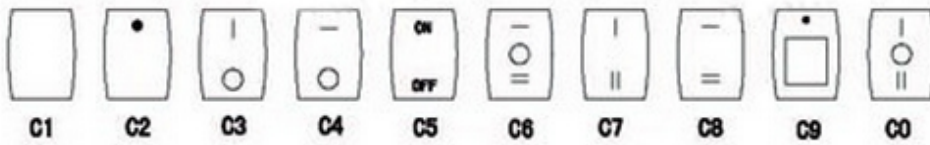

DIMENSIONS (Unit: mm)

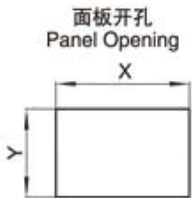
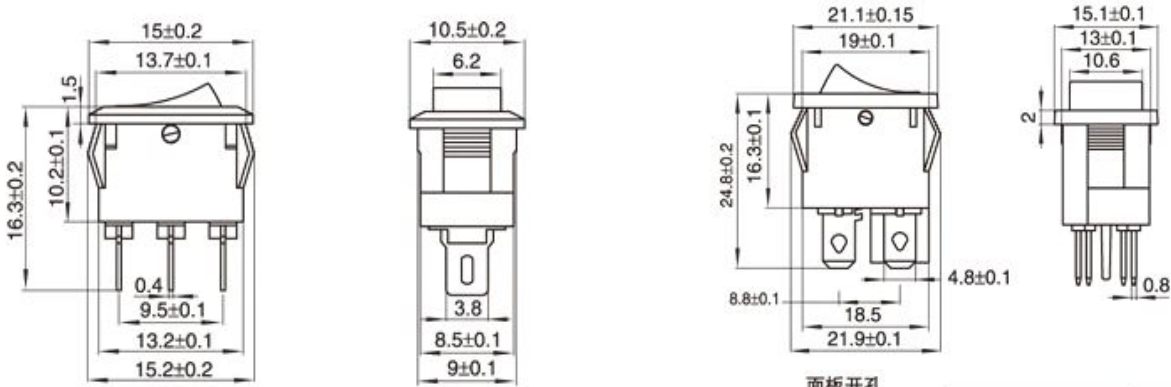



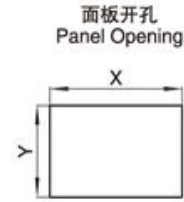





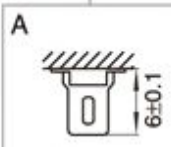



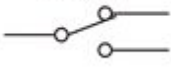
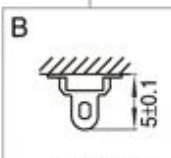



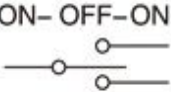
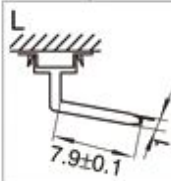

面板厚度 Panel thickness	$X^{+0.10}_0$	$Y^{+0.10}_0$
0.6-1.2	14	9
1.2-2	14.2	
2-3	14.5	

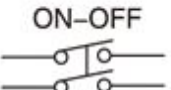
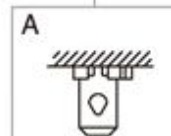

面板厚度 Panel thickness	$X^{+0.10}_0$	$Y^{+0.10}_0$
0.6-1.2	19	13
1.2-2	19.2	
2-3	19.4	

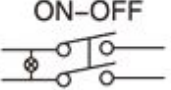
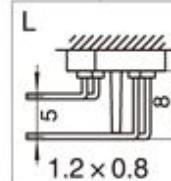
Circuit Diagram

系列号 Series No	电路图 Circuit diagram	端子规格 Terminal	开关标记 Making	颜色代码 Color code
KCD1-101/2P	ON-OFF 	A  3.8 × 0.4	1 空白 No Making 2 ○ — 3 ●	K  W  Y 
KCD1-101/3P	ON-ON 	B  2.6 × 0.4	4 米 米 5 ○ 6 OFF NO	R  G  O 
KCD1-101/D	ON-OFF-ON 	L  7.9 ± 0.1	7 客人要求	B 

系列号 Series No	电路图 Circuit diagram	端子规格 Terminal	开关标记 Making	颜色代码 Color code
KCD1-104	ON-OFF 	A  4.8 × 0.8	1 空白 No Making 2 ○ — 3 ●	K  W  Y 
KCD1-104/N	ON-OFF 	L  1.2 × 0.8	4 米 米 5 ○ 6 OFF NO 7 客人要求	R  G  O  B 