



Industrial & Electrical Components

Draw Spring Inner
Micro Switch

Part No.

NL-10W
NL-5W



- Economical, subminiature, long service life
- Free from overtravel restrictions, easy setting
- Standard operating force, low force force
- RoHS Compliant

ORDERING INFORMATION

NL- - -
 ① ② ③ ④ ⑤ ⑥

1. Ratings

5: 5A at 250VAC
10: 10A at 250VAC

2. Actuator

None: Pin plunger
Z: Hinge lever
W: Simulated roller lever
G: Hinge roller lever

3. Maximum Operating Force

None: 1.1N
F1:1.9N
F2:2.7N
F3:3.6N

4. Contact Form

None: SPDT
2: SPST-NC
3: SPST-NO

5. Terminals

None: Solder terminals
T: Quick-connect terminal (#110)
D: PCB terminals (Even pitch)
D1: Left angle PCB terminals
D2: Right angle PCB terminals

6. Shell Material

None: PMC
P: PBT

SAFETY APPROVAL

UL61058

CSA-C22.2 No.61058-1

Rated voltage	Rated current
AC125V	5A
AC250V	5A

CQC

GB15092.1-2003

Rated voltage	SL- J10	SL- J5
AC125V	10A	5(2)A
AC250V	10A	5(2)A

ENEC (EN61058-1)

Rated voltage	SL- J1	SL- J5	SL- J10
AC125V	0.5A	5A	10A
AC250V	0.5A	5A	10A 5(2)A

TECHNICAL DATA

Item Type	NL-10G / NL-5G	
Allowable operating speed	0.1~1000 mm/s or 0.5~1000 mm/s	
Operating frequency	Mechanical	Max.: 200 times/min
	Electrical	Max.: 30 times/min
Insulation resistance	Min.: 100MΩ (500VDC)	
Contact resistance	50mΩ	
Dielectric strength	BTW same polarity terminals	AC1000V 50/ 60Hz 1min
	BTW current-carrying parts	AC1500V 50/ 60Hz 1min
	BTW terminal & metal parts	AC1500V 50/ 60Hz 1min
Vibration resistance	Malfunction	10~55Hz amplitude 1.5mm
Shock resistance	Durable	1000 m/s
	Malfunction	300 m/s
Expected life	Mechanical life	Min.: 1×10^6 (60 times/min)
	Electrical life	Min.: 1×10^5 (30 times/min)
Protection degree	IP40	
Ambient operation temperature	0°C~+125°C	
Ambient humidity	85%RH	
Weight	Approx. 1.6g (pin plunger type)	

CONTACT SPECIFICATION

Item	NL-10G	NL-5G
Specification	Rivet	
Material	Silver alloy	
Gap (Standard value)	0.5mm	
Inrush current	NC	20A max.
	NO	15A max.
Minimum applicable load	160mA at 5VDC	

CONTACT FORM

SPDT

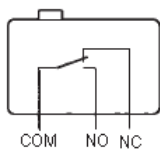

SPST-NC

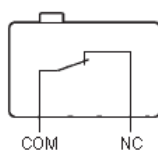

SPST-NO

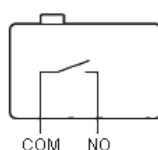

TERMINAL

Solder Terminals

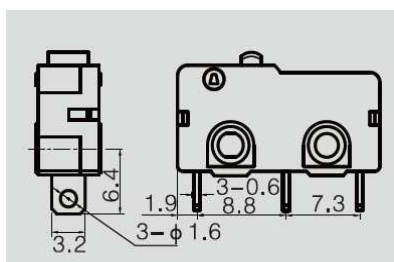

Quick-connect Terminals (#110)

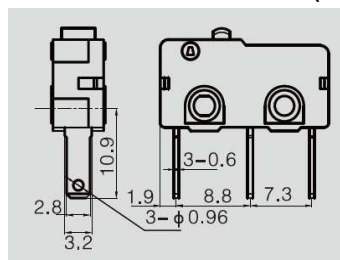

PCB Terminals

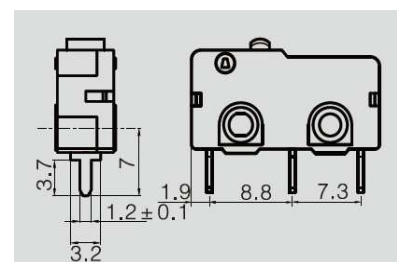

DIMENSIONS (mm)

Hinge Roller Lever Models

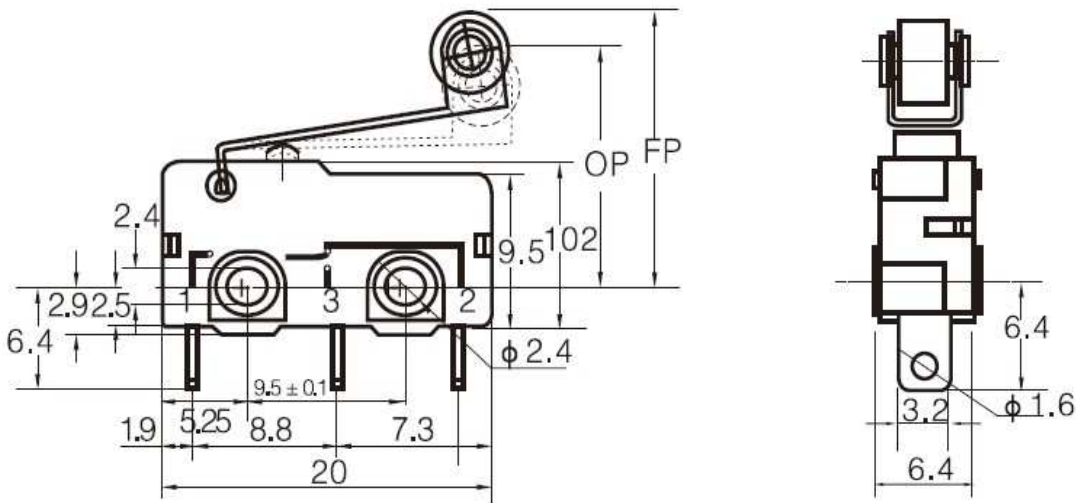

OPERATING CHARACTERISTICS

Operating performance	NL-10G	NL-10GF1	NL-10GF2	NL-10GF3
	NL-5G	NL-5GF1	NL-5GF2	NL-5GF3
OF max.	0.4	0.6	0.8	1.2
RF min.	0.02	0.06	0.1	0.1
PT max.	1.0mm	1.0mm	1.0mm	1.0mm
OT min.	1.0mm	1.0mm	1.0mm	1.0mm
MD max.	17.7mm			
OP	15±1.3mm			

MOUNTING HOLES

Two, 2.4-dia. mounting holes or M2.3 screw holes

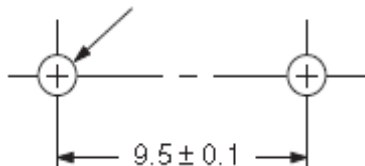

All switches may be panel mounted using M2.3 mounting screws with plane washers or spring washers to securely mount the switch.

Tighten the screws to a torque of 0.23 to 0.26 N·m.