

- High load voltage - up to 480VAC
- 4 ~ 32VDC or 90~250VAC control voltage
- Single Phase, Zero cross-over switching
- LED control input indicator
- Integrated heatsink with DIN rail mounted
- RoHS Compliant
- UL pending

Output (load)

Load type		SPST-NO (1 N/O) Resistive
Load current		40A
Load switching voltage	AC V_{rms}	40 - 480V
Maximum peak voltage	AC V_{pk}	900V
Minimum load current		0.1A
Inrush Current (max.)	10ms	450A
I^2t		880A ² s
Switch type		Zero Cross (Consult factory for Random)
On voltage drop	V AC	1.6V
Leakage current off	mA	≤ 10mA

Input (control)

Control voltage (rated)	V	DC Control: 4 - 32VDC / AC Control: 90 - 250VAC
Control current	mA	< 20mA
Turn-on voltage (min)	V_{min}	DC Control: 3.5VDC / AC Control: 80VAC
Turn-on voltage (max)	V_{max}	DC Control: 35VDC / AC Control: 280VAC
Turn-off voltage	V	DC Control: 2VDC / AC Control: 40VAC

Insulation

Insulation resistance		≤ 500MΩ at 500VDC, 50%RH
Dielectric strength	V AC	≥ 2500V

General Data

Operating time (typical)	mS	Approximately 1/2 cycle of load frequency + ≤1ms
Release time (typical)	mS	Approximately 1/2 cycle of load frequency + ≤1ms
Dimensions	L x W x H	100 x 80 x 107mm
Weight		approx. 940g
Ambient temperature	storage	-30 to 100°C (No icing or condensation)
	operating	-30 to 80°C (with derating). (No icing or condensation)
Relative Humidity		45 - 85% RH

Ordering Code

CAG6-1 / 032 F - 38 - 40 Z

Z - Zero Crossover
R - Random

40 - 40A

38 - 40~440VAC

032 - 4~32VDC
250 - 90~250VAC

Dimensions

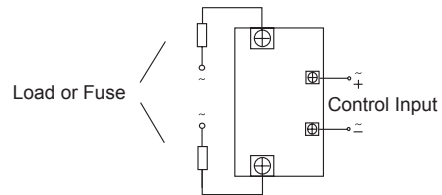
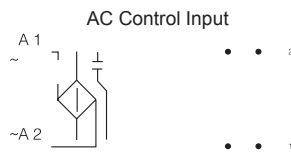
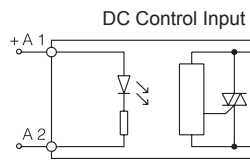
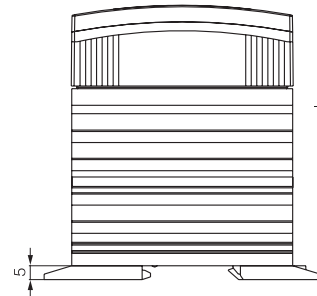
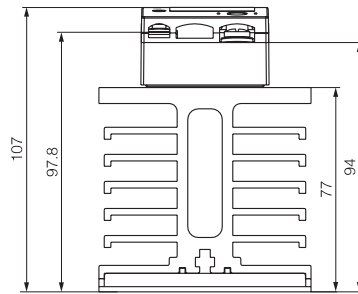
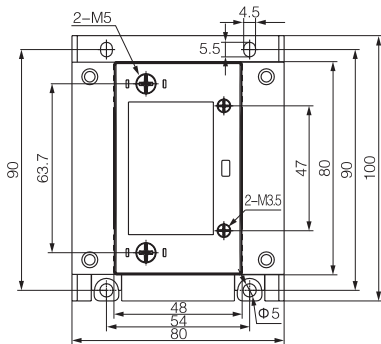

Dimensions in mm

Input Current v. Control Voltage: 4 ~ 32VDC

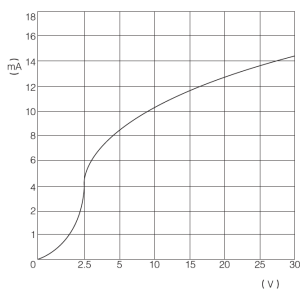

Input Current v. Control Voltage: 90 ~ 250VAC

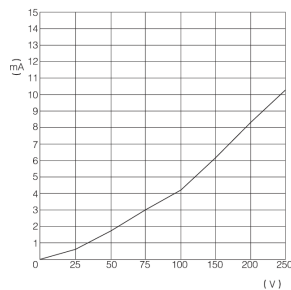

Load Current Derating v. Ambient Temperature

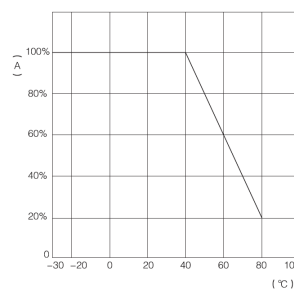

Load Output v. Input Control Action (Zero X-over)

